

2.3

Lever Actuated Valves

Selected valves can be used for technical vacuum too.

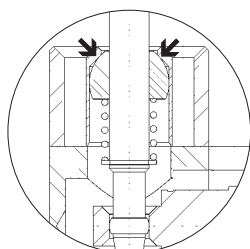

Instead of a rubber-gaitor that never lasts long, Hafner seals all the lever valves with a metallic seal.



Selected models are available for low temperature application.
Temperature-range: - 50° C to + 50° C.
For detailed information refer to chapter 2.9.



316 Selected models are available in stainless steel.
For detailed information refer to chapter 2.10.



Selected models can be equipped with FKM seals for high temperature environment up to 120 °C.

HV 311 501/HV 311 701/HV 311 801 HVR 320 501/HVR 320 701/HVR 320 801

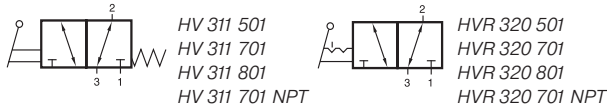

Lever actuated 3/2-way spool valve.

Type HV spring return
Type HVR indexed

If pressure is applied to port 1 the function is normally closed.

If pressure is applied to port 3 the function is normally open.

The lever is sealed by using a metal ball.

Exhaust can be throttled.

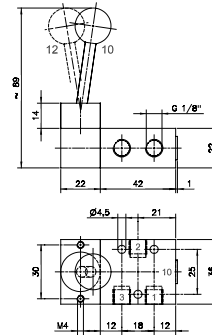

HV 311 501/HVR 320 501

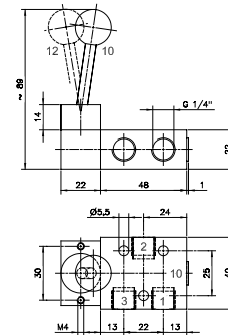

**HV 311 701/HVR 320 701
HV 311 701 NPT/HVR 320 701 NPT**

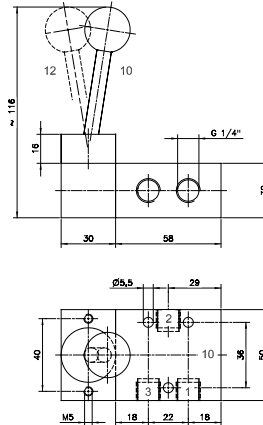

HV 311 801/HVR 320 801

Type	Function	Port size	Air flow	Operating press.	Actuating force	Weight
HV 311 501	spring ret.	G 1/8"	650 l/min	1 - 10 bar	20 N	0,19 kg ❄️
HV 311 701	spring ret.	G 1/4"	1250 l/min	1 - 10 bar	20 N	0,20 kg ❄️ 📦
HV 311 801	spring ret.	G 1/4"	1450 l/min	1 - 10 bar	25 N	0,46 kg
HVR 320 501	indexed	G 1/8"	650 l/min	1 - 10 bar	20 N	0,19 kg ❄️
HVR 320 701	indexed	G 1/4"	1250 l/min	1 - 10 bar	20 N	0,20 kg ❄️ 📦
HVR 320 801	indexed	G 1/4"	1450 l/min	1 - 10 bar	25 N	0,46 kg
HV 311 701 NPT	spring ret.	1/4" NPT	1250 l/min	1 - 10 bar	20 N	0,20 kg
HVR 320 701 NPT	indexed	1/4" NPT	1250 l/min	1 - 10 bar	20 N	0,20 kg

HV 311 101/HV 311 121/HV 311 181 HVR 320 101/HVR 320 121/HVR 320 181

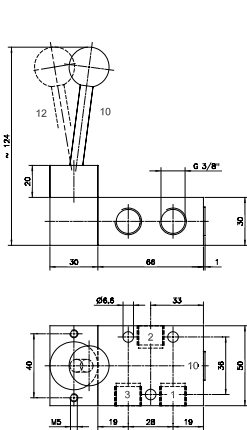

HV 311 101/HVR 320 101

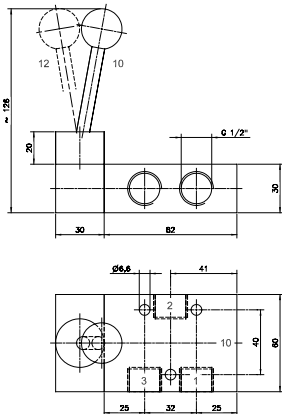

**HV 311 121/HVR 320 121
HV 311 121 NPT/HVR 320 121 NPT**

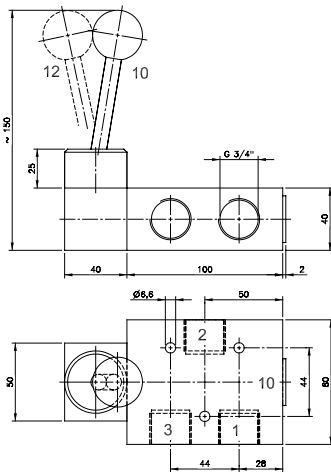

HV 311 181/HVR 320 181

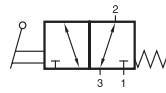

HV 311 101
HV 311 121
HV 311 181
HV 311 121 NPT

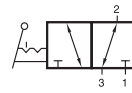

HVR 320 101
HVR 320 121
HVR 320 181
HVR 320 121 NPT



Lever actuated 3/2-way spool valve.

Type HV spring return
Type HVR indexed

If pressure is applied to port 1 the function is normally closed.

If pressure is applied to port 3 the function is normally open.

The lever is sealed by using a metal ball.

Exhaust can be throttled.

Type	Function	Port size	Air flow	Operating press.	Actuating force	Weight
HV 311 101	spring ret.	G 3/8"	2250 l/min	1 - 10 bar	25 N	0,49 kg
HV 311 121	spring ret.	G 1/2"	3000 l/min	1 - 10 bar	32 N	0,69 kg
HV 311 181	spring ret.	G 3/4"	6000 l/min	1 - 10 bar	40 N	1,31 kg
HVR 320 101	indexed	G 3/8"	2250 l/min	1 - 10 bar	25 N	0,49 kg
HVR 320 121	indexed	G 1/2"	3000 l/min	1 - 10 bar	32 N	0,69 kg
HVR 320 181	indexed	G 3/4"	6000 l/min	1 - 10 bar	40 N	1,31 kg
HV 311 121 NPT	spring ret.	1/2" NPT	3000 l/min	1 - 10 bar	32 N	0,69 kg
HVR 320 121 NPT	indexed	1/2" NPT	3000 l/min	1 - 10 bar	32 N	0,69 kg

HV 511 501/HV 511 701/HV 511 801 HVR 520 501/HVR 520 701/HVR 520 801

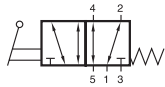

HV 511 501
HV 511 701
HV 511 801
HV 511 701 NPT

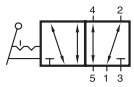

HVR 520 501
HVR 520 701
HVR 520 801
HVR 520 701 NPT

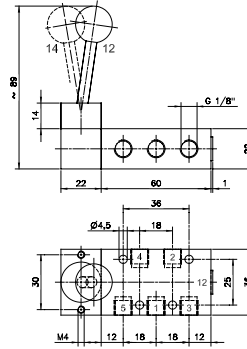

HV 511 501/HVR 520 501

Lever actuated 5/2-way spool valve.

Type HV spring return
Type HVR indexed

The lever is sealed by using a metal ball.

Exhaust can be throttled.

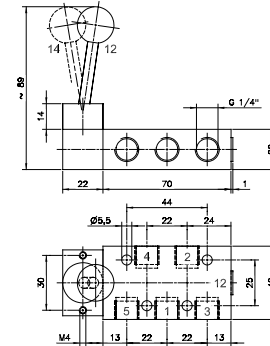

HV 511 701/HVR 520 701
HV 511 701 NPT/HVR 520 701 NPT

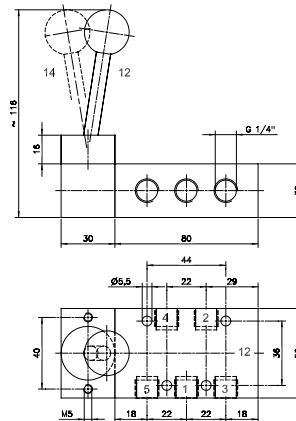

HV 511 801/HVR 520 801

Type	Function	Port size	Air flow	Operating press.	Actuating force	Weight
HV 511 501	spring ret.	G 1/8"	650 l/min	1 - 10 bar	20 N	0,22 kg
HV 511 701	spring ret.	G 1/4"	1250 l/min	1 - 10 bar	20 N	0,24 kg
HV 511 801	spring ret.	G 1/4"	1450 l/min	1 - 10 bar	25 N	0,55 kg
HVR 520 501	indexed	G 1/8"	650 l/min	1 - 10 bar	20 N	0,22 kg
HVR 520 701	indexed	G 1/4"	1250 l/min	1 - 10 bar	20 N	0,24 kg
HVR 520 801	indexed	G 1/4"	1450 l/min	1 - 10 bar	25 N	0,55 kg
HV 511 701 NPT	spring ret.	1/4" NPT	1250 l/min	1 - 10 bar	20 N	0,24 kg
HVR 520 701 NPT	indexed	1/4" NPT	1250 l/min	1 - 10 bar	20 N	0,24 kg

HV 511 101/HV 511 121/HV 511 181 HVR 520 101/HVR 520 121/HVR 520 181

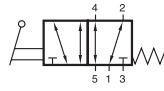

HV 511 101
HV 511 121
HV 511 181
HV 511 121 NPT

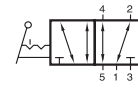

HVR 520 101
HVR 520 121
HVR 520 181
HVR 520 121 NPT

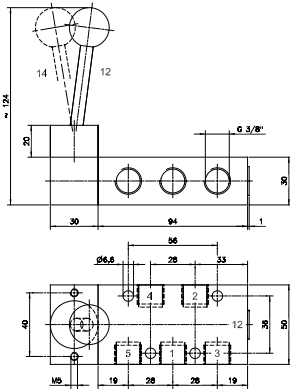

HV 511 101/HVR 520 101



Lever actuated 5/2-way spool valve.

Type HV spring return
Type HVR indexed

The lever is sealed by using a metal ball.

Exhaust can be throttled.

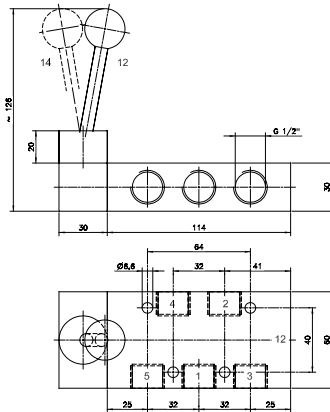

**HV 511 121/HVR 520 121
HV 511 121 NPT/HVR 520 121 NPT**

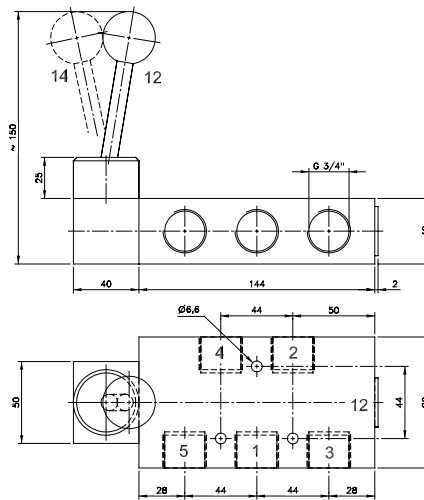

HV 511 181/HVR 520 181

Type	Function	Port size	Air flow	Operating press.	Actuating force	Weight
HV 511 101	spring ret.	G 3/8"	2250 l/min	1 - 10 bar	25 N	0,60 kg
HV 511 121	spring ret.	G 1/2"	3000 l/min	1 - 10 bar	32 N	0,79 kg
HV 511 181	spring ret.	G 3/4"	6000 l/min	1 - 10 bar	40 N	1,64 kg
HVR 520 101	indexed	G 3/8"	2250 l/min	1 - 10 bar	25 N	0,60 kg
HVR 520 121	indexed	G 1/2"	3000 l/min	1 - 10 bar	32 N	0,79 kg
HVR 520 181	indexed	G 3/4"	6000 l/min	1 - 10 bar	40 N	1,64 kg
HV 511 121 NPT	spring ret.	1/2" NPT	3000 l/min	1 - 10 bar	32 N	0,79 kg
HVR 520 121 NPT	indexed	1/2" NPT	3000 l/min	1 - 10 bar	32 N	0,79 kg

HV 53_ 501/HV 53_ 701/HV 53_ 801 HVR 53_ 501/HVR 53_ 701/ HVR 53_ 801

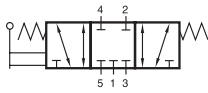

HV 531 501
HV 531 701
HV 531 801
HV 531 701 NPT

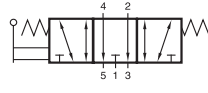

HV 532 501
HV 532 701
HV 532 801
HV 532 701 NPT

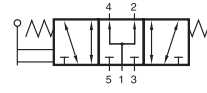

HV 533 501
HV 533 701
HV 533 801
HV 533 701 NPT

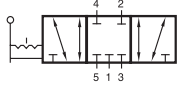

HVR 531 501
HVR 531 701
HVR 531 801
HVR 531 701 NPT



HVR 532 501
HVR 532 701
HVR 532 801
HVR 532 701 NPT

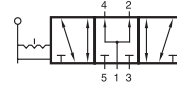

HVR 533 501
HVR 533 701
HVR 533 801
HVR 533 701 NPT



Lever actuated 5/3-way spool valve.

- Type HV spring return to middle position
- Type HVR indexed

- Type 531 centre closed
- Type 532 centre exhausted
- Type 533 centre pressurised

When ordering please complete the type number by 1, 2 or 3 according to the type required.

The lever is sealed by using a metal ball.

Exhaust can be throttled.

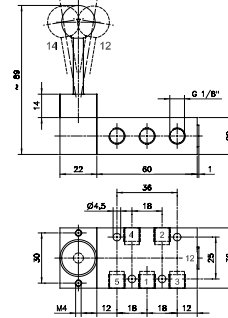

HV 53_ 501/HVR 53_ 501

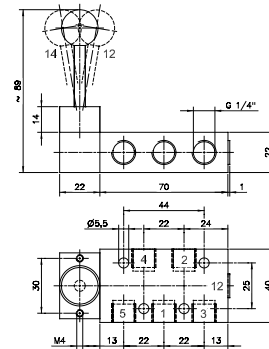

HV 53_ 701/HVR 53_ 701
HV 53_ 701 NPT/HVR 53_ 701 NPT

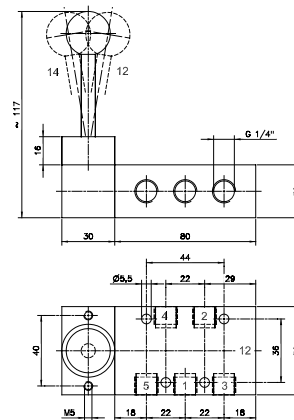

HV 53_ 801/HVR 53_ 801

Type	Function	Port size	Air flow	Operating press.	Actuating force	Weight
HV 53_ 501	spring ret.	G 1/8"	650 l/min	1 - 10 bar	20 N	0,22 kg
HV 53_ 701	spring ret.	G 1/4"	1250 l/min	1 - 10 bar	20 N	0,24 kg
HV 53_ 801	spring ret.	G 1/4"	1450 l/min	1 - 10 bar	25 N	0,55 kg
HVR 53_ 501	indexed	G 1/8"	650 l/min	1 - 10 bar	20 N	0,22 kg
HVR 53_ 701	indexed	G 1/4"	1250 l/min	1 - 10 bar	20 N	0,24 kg
HVR 53_ 801	indexed	G 1/4"	1450 l/min	1 - 10 bar	25 N	0,55 kg
HV 53_701 NPT	spring ret.	1/4" NPT	1250 l/min	1 - 10 bar	20 N	0,24 kg
HVR 53_ 701 NPT	indexed	1/4" NPT	1250 l/min	1 - 10 bar	20 N	0,24 kg

HV 53_ 101/HV 53_ 121/HV 53_ 181 HVR 53_ 101/HVR 53_ 121/HVR 53_ 181

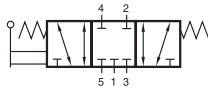

HV 531 101
HV 531 121
HV 531 181
HV 531 121 NPT

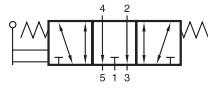

HV 532 101
HV 532 121
HV 532 181
HV 532 121 NPT

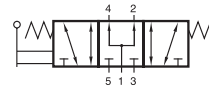

HV 533 101
HV 533 121
HV 533 181
HV 533 121 NPT

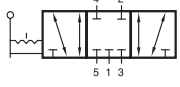

HVR 531 101
HVR 531 121
HVR 531 181
HVR 531 121 NPT



HVR 532 101
HVR 532 121
HVR 532 181
HVR 532 121 NPT

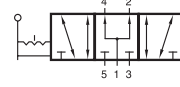

HVR 533 101
HVR 533 121
HVR 533 181
HVR 533 121 NPT

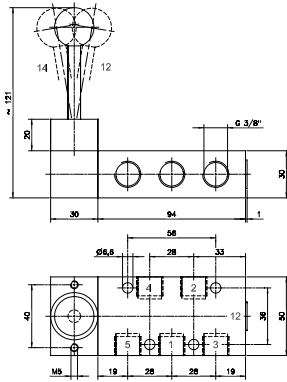

HV 53_ 101/HVR 53_ 101

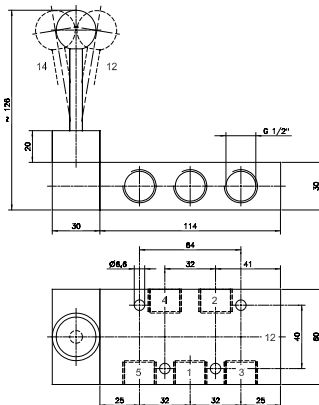

HV 53_ 121/HVR 53_ 121
HV 53_ 121 NPT/HVR 53_ 121 NPT



Lever actuated 5/3-way spool valve with.

Type HV spring return to middle position
Type HVR indexed

Type 531 centre closed
Type 532 centre exhausted
Type 533 centre pressurised

When ordering please complete the type number by 1, 2 or 3 according to the type required.

The lever is sealed by using a metal ball.

Exhaust can be throttled.

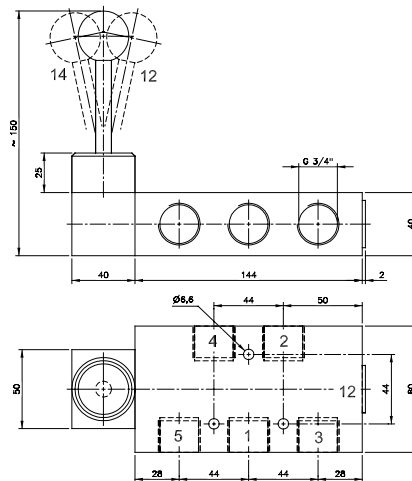

HV 53_ 181/HVR 53_ 181

Type	Function	Port size	Air flow	Operating press.	Actuating force	Weight
HV 53_ 101	spring ret.	G 3/8"	2250 l/min	1 - 10 bar	25 N	0,60 kg
HV 53_ 121	spring ret.	G 1/2"	3000 l/min	1 - 10 bar	32 N	0,80 kg
HV 53_ 181	spring ret.	G 3/4"	6000 l/min	1 - 10 bar	40 N	1,64 kg
HVR 53_ 101	indexed	G 3/8"	2250 l/min	1 - 10 bar	25 N	0,60 kg
HVR 53_ 121	indexed	G 1/2"	3000 l/min	1 - 10 bar	32 N	0,80 kg
HVR 53_ 181	indexed	G 3/4"	6000 l/min	1 - 10 bar	40 N	1,64 kg
HV 53_ 121 NPT	spring ret.	1/2" NPT	3000 l/min	1 - 10 bar	32 N	0,80 kg
HVR 53_ 121 NPT	indexed	1/2" NPT	3000 l/min	1 - 10 bar	32 N	0,80 kg

Examples for customer-specific products

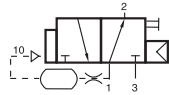

SUH 310 502

3/2-way G 1/8" impulse valve with manual override. Valve is interrupting a pneumatic signal after a defined time-period, pressing the manual override brings the signal back.



P 510 801 METS

Single-pilot 5/2-way valve with metric ports. Head is offering two pilot ports, both M10 x 1.

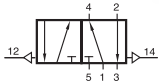
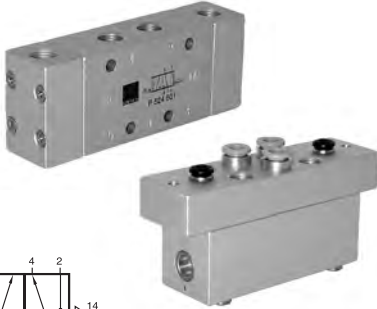

P 524 501/P 524 502/P 524 404

5/2-way Bleed valves. Negative switching double pilot valve.



PH 520 502

Double pilot G 1/8" valve with manual override. Valve offers 2 pins that stick out at the ends of the valve. Those can be used as manual override or to indicate the position. Versions to be put onto manifold plates orifice size 5 mm have also been manufactured.

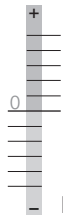

P 310 701 VIT

Pneumatically actuated 3/2-way valve G 1/4" with FKM seals. Temperature range 0° C to 120° C.

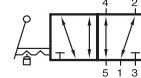

HVR 520 701

Lever actuated 5/2-way spool valve, indexed. The user can put a padlock through the 5 mm hole of the extended spool and hereby lock the valve. Temperature range: 0°C to 120°C. Seals made from FKM.



HVR 520 801 Z

G 1/4" 5/2-way lever actuated valve, indexed. Valve can not be switched without thoroughly pulling the lever. This feature can also be included into 3/2-way valves, 5/3-way valves, valves with Namur-interface or valves with spring return. Valve can be used where prevention against unintended actuation is in need.

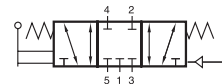
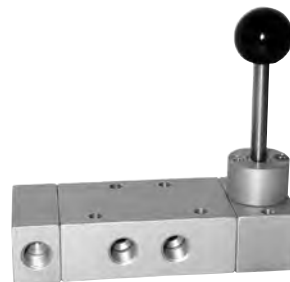

HVP 531 501

Lever actuated 5/3-way valve, centre position closed, with spring return to middle position. When a pneumatic signal is applied to port 12, spool moves to or is held in the position where 1 is open to 2 and 4 to 5. Commercial vehicle application.